

MODEL WSP-i350

(3inch Industrial Printer)

Rev. 3.0



WOOSIM SYSTEMS Inc.

**#501, Daerung Technotown 3th,
448, Gasan-Dong, GeumChun-Ku,
Seoul, Korea**

Tel : +82-2-2107-3700

Fax : +82-2-2107-3707

URL: <http://www.woosim.com>

All specifications are subjected to change without notice

■ Copyright

WSP-i350 3inch Industrial printer operator's manual.

Copyright ©2010 by Woosim Systems Inc.

All rights reserved.

The information contained in this manual is the property of Woosim Systems Inc.

And may not be reproduced in whole or in part without the prior written permission of Woosim Systems Inc.

■ Trademark



a registered trademark of Woosim Systems Inc.

All other trademark are the properties of their respective companies.

■ Caution

Some semiconductor devices are easily damaged by static electricity. You should turn the printer "OFF", before you connect or removed the cable on the rear side, in order to guard the printer against the static electricity. If the printer is damaged by the static electricity, you should turn the printer "OFF"

■ Notice

The contents of this manual are subject to change without notice.

■ Introduction

The **WSP-i350** is the ideal solution for Mobile banking system , Retail, point of sales, Credit card Transaction, other traveling and mobile computing etc.

The general features of **WSP-i350** printer are as follows:

- ▶ Compact size (120×130.5×58.3mm)
- ▶ Light weight(560g) for true mobility [standard]
- ▶ Very silent printing thru direct thermal printing method
- ▶ High speed (80mm/sec, MAX)
- ▶ High resolution(203dpi : 8dots/mm).
- ▶ UART(RS-232C or TTL), Bluetooth Ver2.1 + EDR, USB[option]
IrDA Ver1.0(SIR) [option], Wireless LAN (IEEE802.11b/g)[option] interface
- ▶ Support Magnetic Stripe Reader[option]
- ▶ Support Graphic LCD(128×32dots) with Blue LED Backlight
- ▶ Support text and graphic printing
- ▶ Intutive LED's indicate Power(on/off), Error
- ▶ Easier paper roll loading by CLAMSHELL design
- ▶ One touch paper cover
- ▶ Printer door open & Paper-out sensor
- ▶ Easier maintenance with self-diagnostic.
- ▶ In field programming – Update Firmware, Download Fonts and Logos
- ▶ Water-resistant construction.(IP54 – Certified)
- ▶ Microsoft Windows XP / VISTA / 7 / CE / Linux / Android compatible.
- ▶ Flow control : Software (XON/XOFF)
※ Hardware flow control not supported in printer.
- ▶ Free fall: 1.5 meter onto concrete
- ▶ Agency Approvals



■ Operating Precautions

Please follow the precautions below to enjoy and maintain the full performance of the printer.

▶ Using the Printer

- Be careful not to drop or bump the printer on a hard surface.
- Do not install the printer in direct sunlight or such areas.
Suitable environment for the use of the printer is as follows:
 - ◆ Operating temperature : -10°C to 50°C
 - ◆ Relative humidity : 30% to 80%
- Do not install the printer near devices that generate strong electromagnetic fields such as a copy machine.
- Do not open the platen cover during printing .
- Do not remove or reinstall the communication cable during printing or transmission.
- Do not touch the connectors of the communication during printing.
- Switch the POWER OFF when not in use.
- Do not use alcohol or other solvent.
- The AC adapter, the battery charger and the battery pack may become warm when in use. This is normal and is not a malfunction.
- When the battery pack is used at low temperature, the length of time the printer can be used may be shortened.

▶ Thermal Paper Handling

- Store the thermal paper in a cool, dry and dark place.
- Do not rub the paper with hard object.
- Do not leave the paper with hard object.
- Do not allow plastic film, erasers, or adhesive tape to touch the paper for long periods.
- Do not stack the thermal paper with diazo copies immediately after copying or wet-type copies.
- Do not use chemical glue.
- Always use the clean thermal paper.

■ Note

This equipment has been tested and found to comply with the limits for a Class B digital device, pursuant to Part 15 the FCC Rules.

These limits are designed to provide reasonable protection against harmful interference in a residential installation.

These equipment generates, uses and can radiate radio frequency energy and, if not installed and used in accordance with the instructions, may cause harmful interference to radio communications.

However, there is no guarantee that interference will not occur in a particular installation. If this equipment does cause harmful interference to radio or television reception , which can be determined by turning the equipment off and on, the user is encouraged to try to correct the interference by one or more of the following measures:

- Reorient or relocate the receiving antenna.
- Increase the separation between the equipment and receiver.
- Connect the equipment into an outlet on a circuit different from that to which the receiver is connected.
- Consult the dealer or an experienced radio/TV technician for help.

CONTENTS

1. Outline	8
1.1. Model classifications	8
1.2 Product Part Number System	8
1.3. Specifications	9
2. Setting up the printer	11
2.1. Printer & Accessories	11
2.2. Printer Features	12
2.3. Dimensions	13
2.4. Replacing paper roll.....	14
2.5. Power supply	15
2.5.1. Specified power supply.....	15
2.5.2. Installing the battery	15
2.5.3. Recharging the battery pack.....	16
2.6. Set operation mode	17
2.7. Confirmation of the Wireless-LAN information	20
2.7.1. MAC Address printing.....	20
2.7.2. Confirmation of the Wireless-LAN setting information.....	20
3. Interface	21
3.1. UART(RS-232C or TTL) & USB	21
3.2. Infrared data communication	23
3.3. Bluetooth	24
3.4. Wireless LAN.....	24
4. Using the printer	25
4.1. Control panel	25
4.2. The self test.....	26
4.3. Using the Accessory	26
4.3.1. Using the Shoulder strap.....	26
4.3.2. Using the Belt clip	27
5. Consumable Parts	28

5.1. Recommended paper.....28
5.2. Printing position.....28

1. Outline.

1.1. Model classifications.

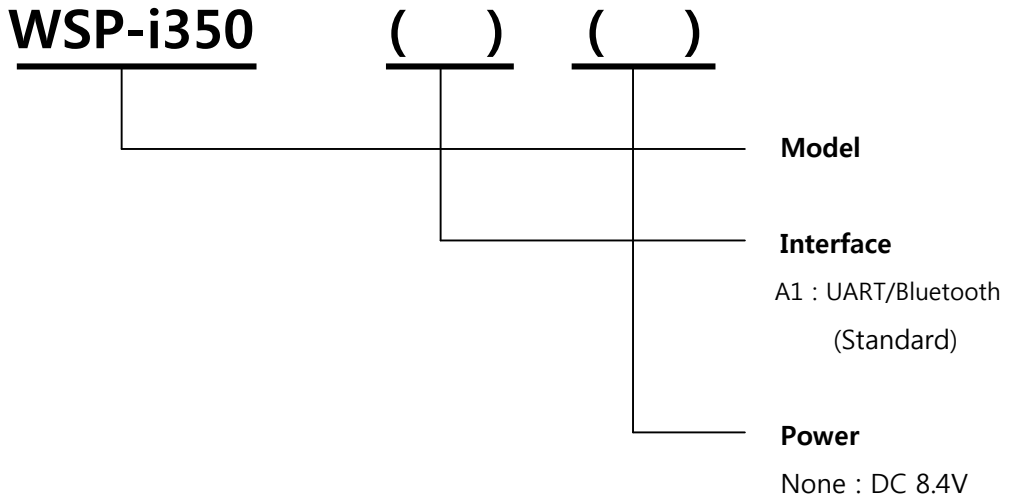

1.2 Product Part Number System

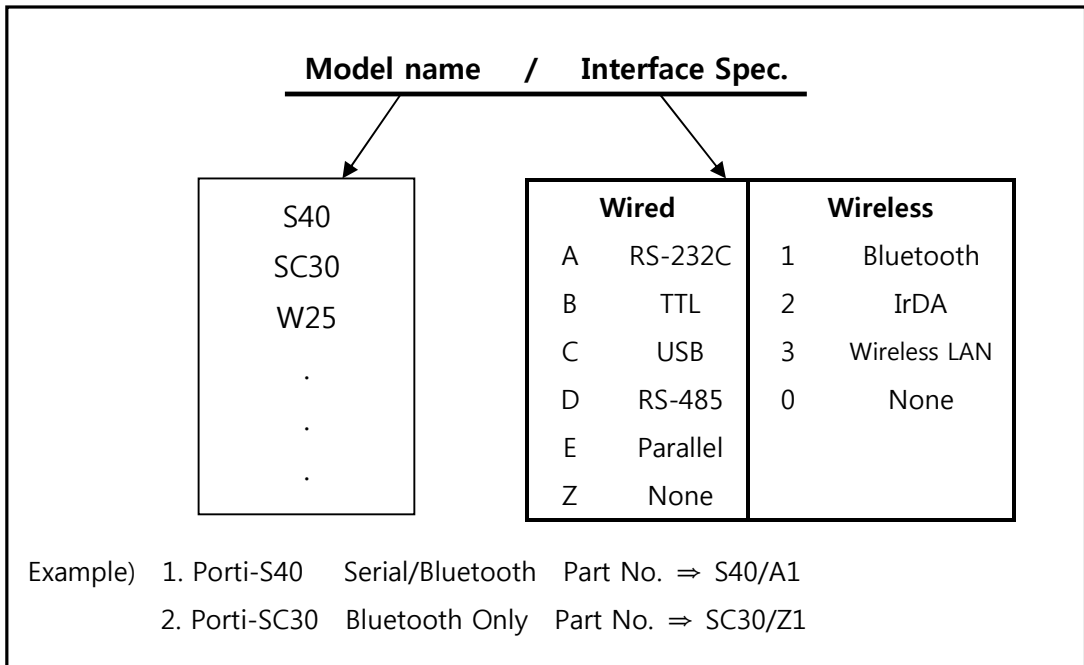

1.3. Specifications.

Item	Specifications
Print method	Direct thermal line printing
Characters per line	64cpl (MAX)
Character size	Eng: 9*24dots, 12*24dots Kor: 16*24dots, [24*24dots]
Optional Characters	Simplified/Traditional Chinese, Arabic, Cyrillic, Russian, Turkish, Greek, Japanese, Persian, Latin9 and Others upon request.
Resolution	203dpi, 8dots/mm
Print width	3-inch (72mm, 576dots)
Print speed	80mm / sec (MAX)
Dimension	120 * 130.5* 58.3 mm
Weight	560g (Including battery & roll paper) [standard] 566g (Including battery & roll paper) [MSR option]
Interface	UART(RS-232C or TTL), Bluetooth Ver 2.1 + EDR, IrDA Ver1.0(SIR)[option], USB[option] Wireless LAN interface(IEEE802.11b/g) [option]
Paper roll	Thermal roll paper (80mm wide, 50ø)
Barcodes	1-dimension : Code128, Code39, I2/5, Code93 UPC, EAN, KAN, JAN, CODABAR 2-dimension : PDF417, QR Code, DATA Matrix
Driver	Microsoft Widows XP / VISTA / 7 Windows CE, Linux, Android OS driver compatible
Black mark	Support black mark detection
H/W Spec	MCU : 32bits RISC, FLASH : 4M bytes, RAM : 8M bytes
Receive buffer size	1M bytes
MSR [option]	ISO 7810 / 7811 / 7812 1&2 or 2&3 Track Reading
LCD	128×32 Dots FSTN (Blue LED Backlight)
Battery	Rechargeable 7.4V DC, 1,800mAh (Li-ion)

(Continue...)

Item	Specifications	
Battery duration	1 hour continuous printing	
Battery charger	Input (100~250V AC, 50~60Hz) Output(8.4VDC/0.8A), 4hours full charge time	
Environment conditions	Temperature	-10°C ~ 50°C (operating) -10°C ~ 70°C (storage)
	Humidity	30% - 80% (operating) 10% - 90% (storage)
MCBF(Mean Cycle Between Failure)	Mechanical	37,000,000 lines
	Head	Approximately 50 Km

< Table 1 >

2. Setting up the printer.

2.1. Printer & Accessories

Your printer box should include these items. If any items are damaged or missing, please contact your dealer for assistance.



WSP-i350

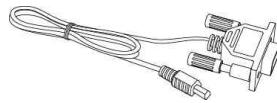

Communication cable



Thermal roll paper



Battery Pack

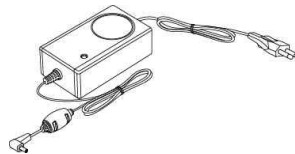

Battery charger adaptor

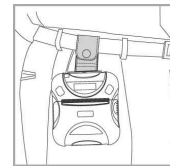

Belt clip

▼ OPTIONAL

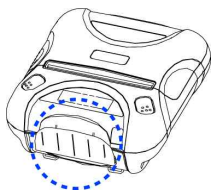

MSR



Shoulder strap

2.2. Printer Features

► Part Name

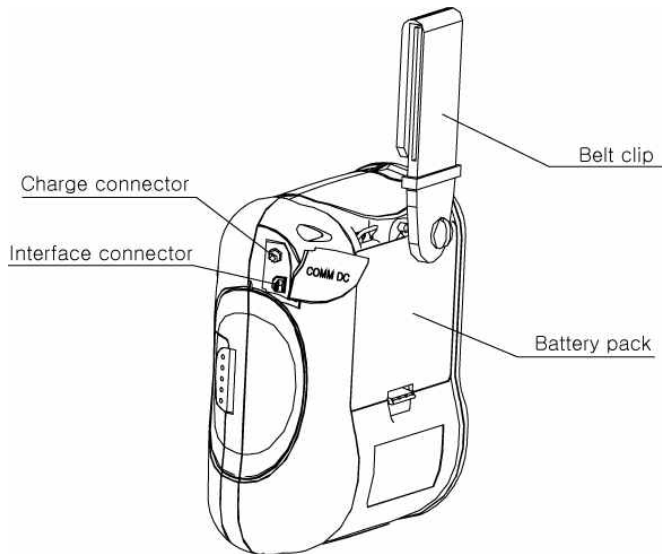
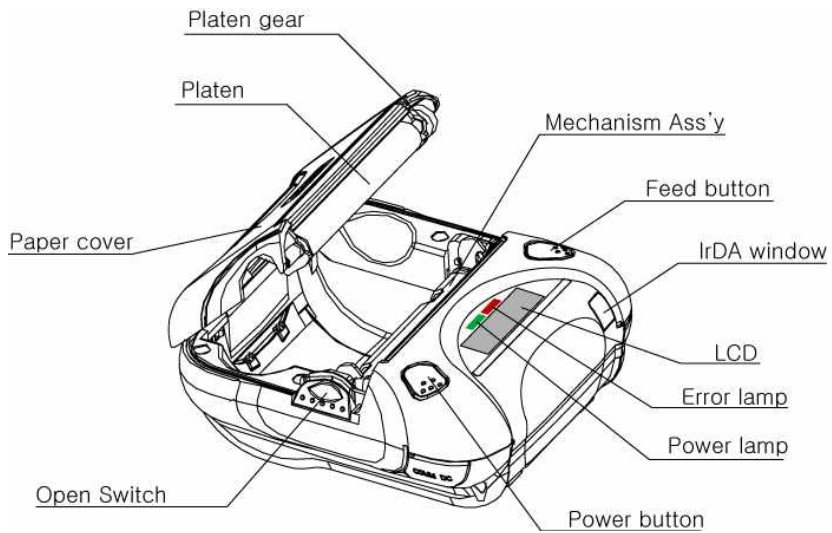

2.3. Dimensions

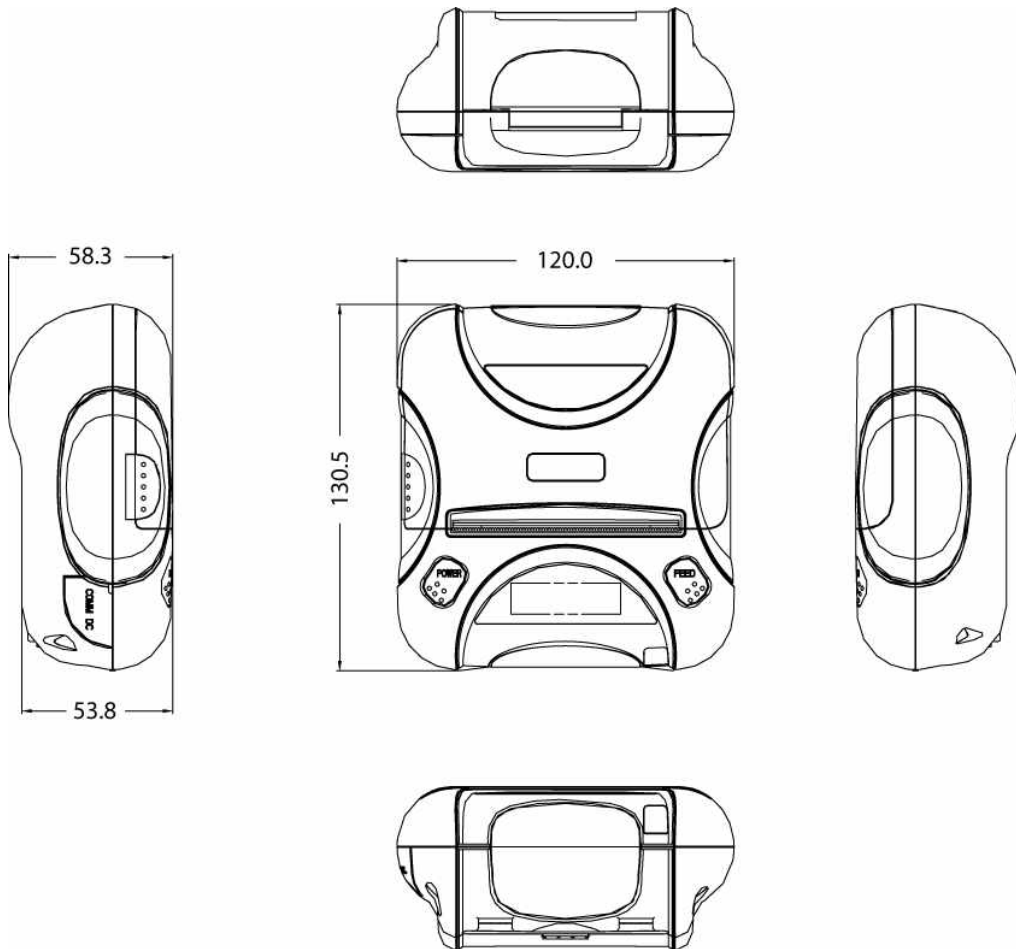

2.4. Replacing paper roll.

Note : Be sure to use paper rolls that meet the specifications.

Do not use paper rolls that have the paper glued to the core because the printer can not detect the paper end correctly.

1. Make sure that the printer is not receiving data; otherwise, data may be lost.
2. Open the paper cover as the “One-Touch” way by pressing the button in the arrow direction like the picture.

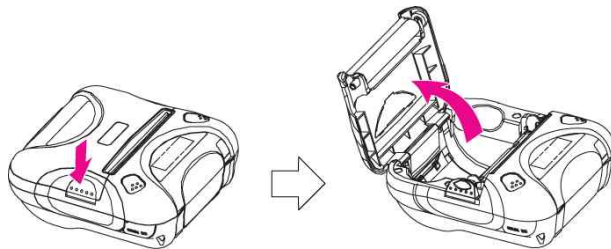

3. Insert a new paper roll as shown.

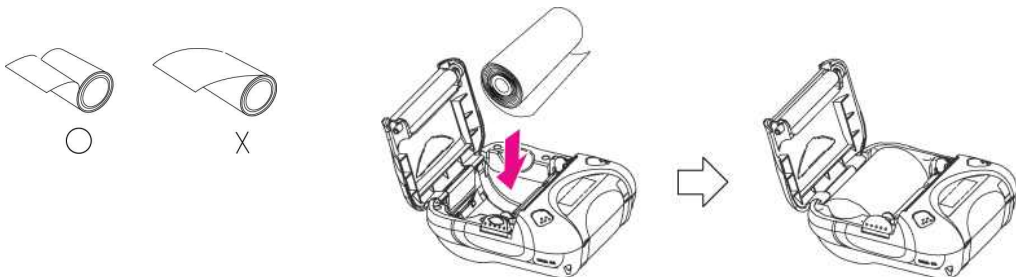

4. Tear the excess paper off using the edge of paper door as a tear bar.

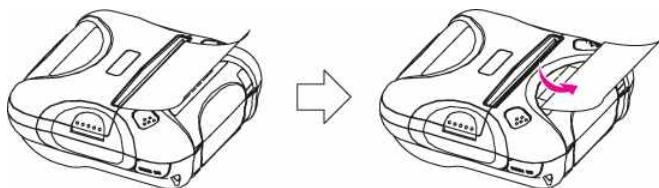

2.5. Power supply

2.5.1. Specified power supply

The following specification is requested for Power supply.

Battery Charger : DC 8.4V/0.8A

Avoid using power supply which its power capacity of power current is extremely high.

2.5.2. Installing the battery

- NOTE :**
- Before installing or removing the battery pack, ensure the printer is OFF.
 - If the printer is not used for long period of time, remove the battery pack from the printer.

① To install battery pack, proceed as follows:

Insert the battery in the arrow direction and make sure the lock completed

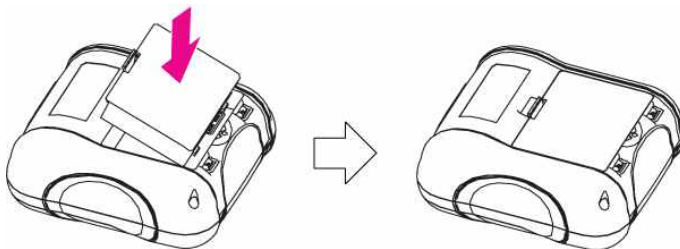

② Reverse the order to remove the battery pack.

2.5.3. Recharging the battery pack

For recharging the battery pack, install the battery pack in the printer. Insert the Battery Charger to the charge connector of the printer.

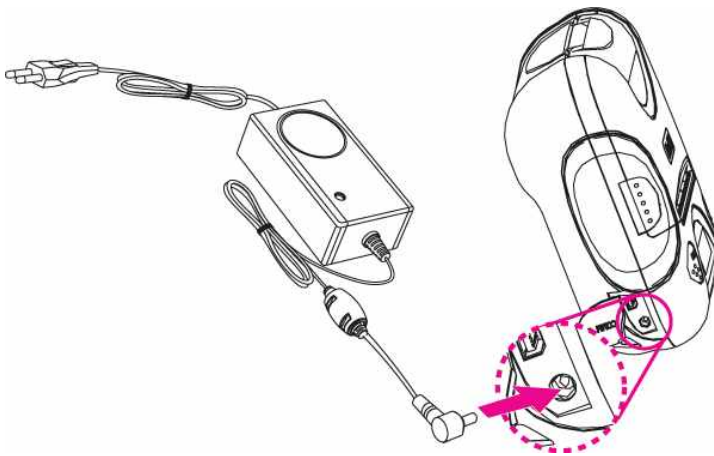

- NOTE :**
- While charging the printer, turn off the printer power.
 - Do not remove the battery during charging.
 - The battery is consumable parts and when purchasing, compared to the use hour is gradually decreases. (Warranty 6 month)
 - If the printer is not used for a long time, unplug the power cord from the printer and outlet.
 - The recharging time depends on the voltage level and ambient temperature of the battery. Normally, it takes about 4 to 5 hours to recharge a battery pack.
 - You must use only the supplied adapter.
 - Red Lamp : charging the battery.
Green Lamp: charging is finished.

2.6. Set operation mode

In keeping on pressing the Feed and Power button simultaneously until after the **ERROR lamp** blinks 5 times, the printer comes out at the circumstance to change the printer mode. (refer Table 2)

- **FEED button** : changing Printer MODE status.
- **POWER button** : changing OPTION status.

[Example] The defaults of the printer are :

UART / 9600 bps / 8 data bit / No parity /1 stop bit / Density low / Quality low / Mark use / Sensor low / Power down 5 minute

If a user wants to modify the defaults with

Bluetooth / 57,600 bps / 7 data bit / Odd parity /2 stop bit / Density high / Quality high/ Mark no use / Sensor medium1 / Power down no use

- ▶ Press MODE & POWER Button during the **Error Lamp** flickers 5 times.
 - You will see present **COMMUNICATION** mode in the LCD. (UART)
 - Press the **POWER Button** twice. And then, interface mode has set to **Bluetooth** mode.
- ▶ When you press **FEED button** once.
 - You will see present **BAUD RATE** mode in the LCD. (9600 bps)
 - Press **POWER Button** 3 times. And then, **BAUD RATE** has set to **57,600 bps**.
- ▶ When you press **FEED button** once.
 - You will see present **DATA BIT** mode in the LCD. (8 Data bit)
 - Press **POWER Button** once. And then Data Bit has set to **7 DATA BIT**.
- ▶ When you press **FEED button** once.
 - You will see present **PARITY** mode in the LCD. (No parity)
 - Press **POWER Button** once. And then the Parity bit has set to **ODD Parity Bit..**
- ▶ When you press **FEED button** once.
 - You will see present **STOP BIT** mode in the LCD. (1 stop bit)
 - Press **POWER Button** once. And then the density has set to **2 Stop bit**.

- ▶ When you press **FEED button** once.
 - You will see present **DENSITY** mode in the LCD. (Density low)
 - Press **POWER Button** twice. And then the density has set to **Density high**.
- ▶ When you press **FEED button** once.
 - You will see present **Quality** mode in the LCD. (Low)
 - Press **POWER Button** once. And then the quality has set to **Quality high**.
- ▶ When you press **FEED button** once.
 - You will see present **MARK** mode in the LCD. (Use)
 - Press **POWER Button** once. And then the mark has set to **Mark no use**.
- ▶ When you press **FEED button** once.
 - You will see present **SENSOR** mode in the LCD. (Low)
 - Press **POWER Button** once. And then the sensor has set to **Sensor medium1**.
- ▶ When you press **FEED button** once.
 - You will see present **POWER DOWN** mode in the LCD. (5 minutes)
 - Press **POWER Button** once. And then the Power down has set to **Power down no use**.

If all the mode have set, press the **POWER Button** and the **FEED Button** at the same time. After then release the buttons at the same time.

**Bluetooth / 57600bps / 7 data bit / Odd parity / 2 stop bit / Density high
/ High/No use / Medium 1 / No use**

MODE	OPTION		
	IrDA	Bluetooth	WLAN
Communication Port	UART(RS-232C)	UART(RS-232C)	UART(RS-232C)
	Protocol UART (RS-232C)	Protocol UART (RS-232C)	Protocol UART (RS-232C)
	Raw IrDA	Bluetooth	WLAN
	Protocol IrDA	Protocol Bluetooth	Protocol WLAN
	Standard IrDA		
Baud Rate	9600 bps		
	19200 bps		
	38400 bps		
	57600 bps		
	115200 bps		
Data Bit	7 Data bit		
	8 Data bit		
Parity Bit	No Parity		
	Odd Parity		
	Even Parity		
Stop Bit	1 Stop bit		
	2 Stop bit		
Density	Density Low		
	Density Medium		
	Density High		
Quality	Low		
	High		
Mark	No use		
	Use		

Continue...

MODE	OPTION
Sensor	Low
	Medium1
	Medium2
	High
Power Down	No use
	1 minute
	2 minute
	3 minute
	4 minute
	5 minute

< Table 2 >

2.7. Confirmation of the Wireless-LAN information

2.7.1. MAC Address printing

- ▶ MAC address which is set to the printer can be printed out in pressing the Power and Feed button simultaneously and taking off them shortly after the **ERROR lamp** blinks

2.7.2. Confirmation of the Wireless-LAN setting information

- ▶ Press the Power button in the printer turning on
As the Power lamp turns on, MAC Address is indicated.
- ▶ IP Address on LCD is indicated in pressing the Power button once again
- ▶ Subnet mask on LCD is indicated in pressing the Power button once again
- ▶ Gateway IP on LCD is indicated in pressing the Power button once again
- ▶ DNS sever IP on LCD is indicated in pressing the Power button once again

※ Since the configuration of Wireless LAN can not be done with the printer in person, you are required to use the Wireless LAN-setting program which WOOSIM offers

3. Interface

3.1. UART(RS-232C or TTL) & USB

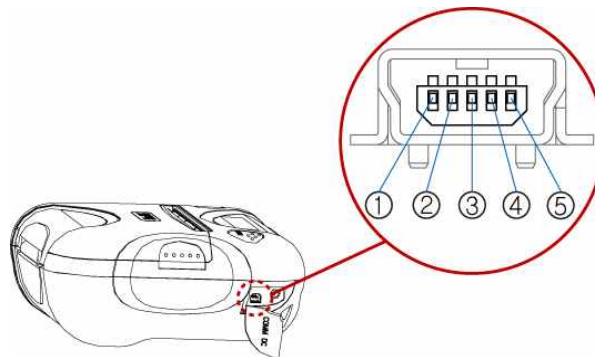

The WSP-i350 printer has a UART(RS-232C or TTL) & USB interface and is connected by means of a 5 pin mini USB socket. In the following table, the signals present on the Mini- USB socket are listed:

① UART(RS-232C or TTL)

Pin No.	Name	Direction	Function
1	TxD	Output	Transmit Data
2	RxD	Input	Receive Data
3	CTS	-	-
4	NC.	-	-
5	GND	-	Ground

② USB

Pin No.	Name	Function
1	VCC	+5V
2	DM	DATA “-”
3	DP	DATA “+”
4	NC.	-
5	GND	Ground

NOTE : ● When data receiving, when it removes the Communication cable, it loses a data.

3.2. Infrared data communication

The WSP-i350 has a serial interface for bi-directional data exchange. The infrared port is the right side of the front part.

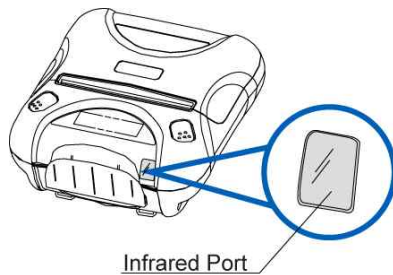

1. To use the WSP-i350's infrared port by a Computer or a Personal Digital Assistant (PDA) with IR port is required.
2. Position a PDA conforming to the specifications in point not more than 50 centimeter away from the printer's infrared port. Make sure the two ports are in front of each other with an angle of not more than 15° on the four sides.

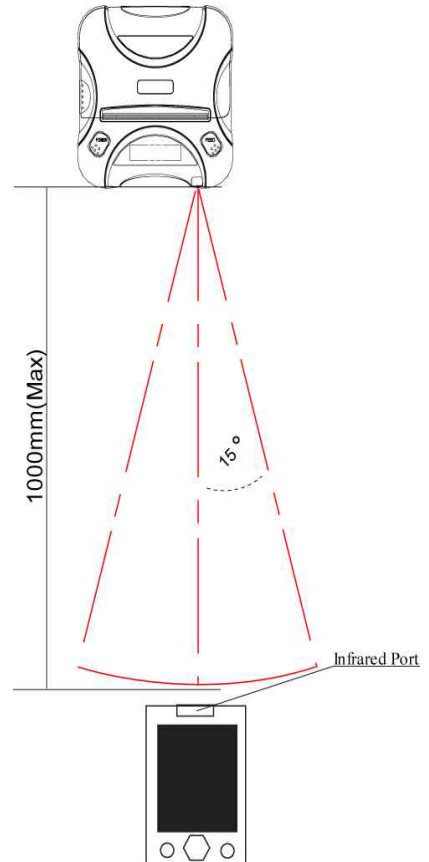

NOTE : ● When infrared ray communication doing, directness it does not see the IrDA window roll up.
Eye damage there is a danger.

3.3. Bluetooth

Category	Specification
Bluetooth Spec.	Bluetooth Ver2.1 + EDR / Class2 (10m)
Frequency Range	2.4GHz ISM BAND
Data Transmission Rate	57600bps Fixed.
Data bit	8 Data bit Fixed.
Parity bit	No parity Fixed.
Stop bit	1 Stop bit Fixed.

3.4. Wireless LAN

Category	Specification	
Interface	Network	IEEE802.11b/g
Protocol	TCP, UDP, IP, ICMP, ARP, DHCP, PPPoE DNS lookup, DDNS(Dynamic DNS), WEP	
Communication Mode	T2S	TCP Server Mode
	COD	TCP Client Mode
	ATC	TCP Server / Client (AT command emulation)
	U2S	UDP

4. Using the printer

4.1. Control panel.

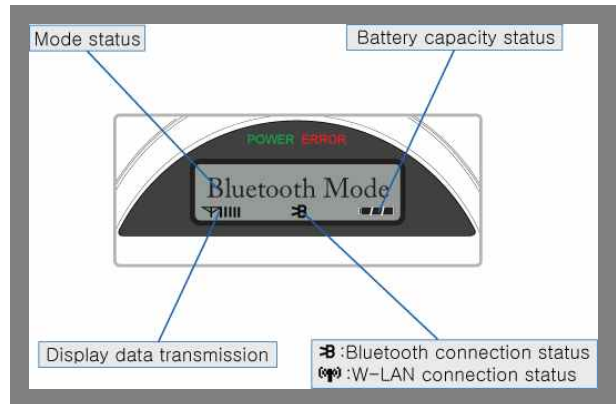
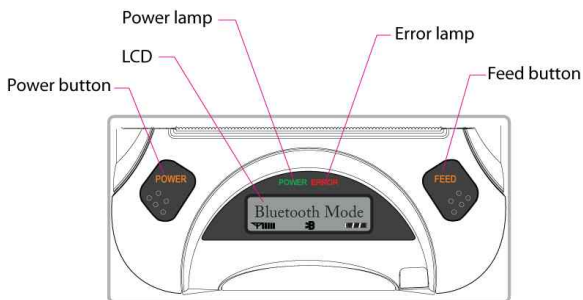

► BUTTON

- **FEED Button** : When the printer is on, paper can be feed manually by pressing and holding the FEED button for more than one second.
- **POWER Button:**
 - ① When of 5 or more seconds presses and power comes to on or off.
 - ② After pressing the POWER and the FEED button simultaneously, if the ERROR lamp 5 turn signals POWER button is converted with MODE functions.
- In keeping on pressing the **Feed and Power button** simultaneously until after the **ERROR lamp** blinks 5 times, the printer comes out at the circumstance to change the printer mode. (Refer to **2.6. Set operation mode** for details about mode conversion)

► LAMP

- **POWER lamp(GREEN)** : Printer is ON and ready to receive data.
- **ERROR lamp(RED)** : Indicated a fault condition or a printer error.
(i.e : no paper, paper cover opened. etc.)

► LCD

- LCD will display most of the printer status.
(i.e : current printer status, paper out, indicated remaining battery, Bluetooth connection etc.)

4.2. The self test

The self test procedure will check most of the printer functions.

For self test, turn on the power while holding down the FEED Button.

The Self-Test checks the following :

- 1) Make sure paper roll has been installed properly.
- 2) The Self-Test prints the current printer status, which provides the control ROM version and the communication method setting.
- 3) After printing the current printer status, Self-Test will print a pattern using the built-in character set.
- 4) The Self-Test automatically ends.

The printer is ready to receive data as soon as it completed the self test.

4.3. Using the Accessory

4.3.1. Using the Shoulder strap

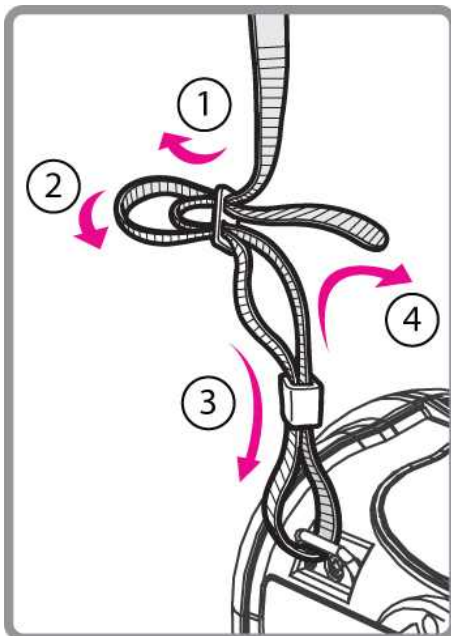

Please sling it over your shoulder after fixing the shoulder strap to the printer in the order of the illustration.

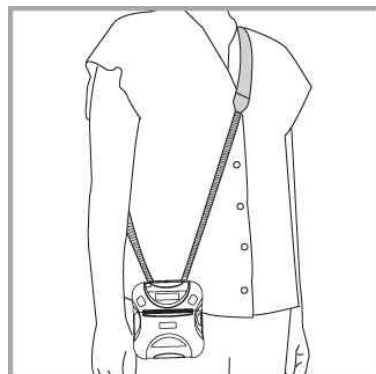

4.3.2. Using the Belt clip

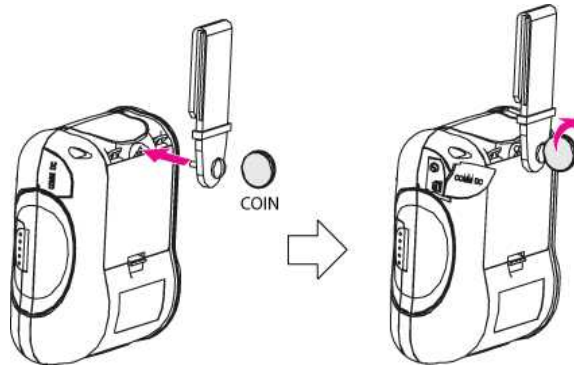

Following the instruction of the arrow, please put the belt clip in the hole and turn and fix the screw to the right by using a thing like a coin.

Afterward, you can use it like the picture below

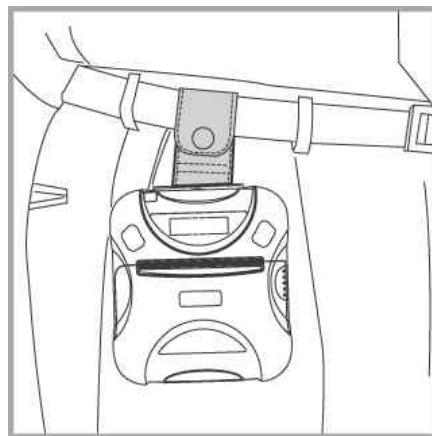

5. Consumable Parts.

5.1. Recommended paper.

Type	: Thermal Paper
Paper width	: 80mm
Paper thickness	: $60 \pm 5 \mu\text{m}$
Outer diameter	: $\varnothing 50\text{mm}$ or less
Recording side	: Outside of roll



Cautions

1. Do not paste the paper to the core. And the roll paper which has Near end mark printing on its near end is recommended.
2. Chemicals or oil may change the color of paper, or printed Characters may fade.
3. Change of paper color starts from approx 70 °C.
Pay attention to heat, humidity and sun light.
4. Color of paper may be changed by being scratched by nail or hard metal, etc

5.2. Printing position.

